



LINER ORDER / QUOTE

COMPANY _____
 ADDRESS _____
 CITY, STATE, ZIP _____
 PERSON TO CONTACT _____
 PHONE NUMBER () _____
 JOB NAME _____
 SHIP VIA _____

DATE _____

P.O. NUMBER _____
 ORDER.....QUANTITY _____
 QUOTE.....QUANTITY _____
 CONFIRMING PHONE ORDER

* NOTE BELOW DIFFERENT SHIPPING ADDRESS

Shape of Pool

- RECTANGLE [CHECK CORNERS BELOW]
 - SQUARE (90 DEGREE)
 - RADIUS OF _____ INCHES
 - DIAGONAL OF _____ INCHES
- OVAL [SEE BACK PAGE]
- GRECIAN [SEE BACK PAGE]
- OTHER [INCLUDE DRAWING]

Safety Ledge

- NO LEDGE
- LEDGE OF _____ INCHES

Stairs

- NO STAIRS
- FIBERGLASS [NOTE LOCATION BELOW]
 - [CHECK BELOW FOR RADIUS PANEL POOLS]
 - RADIUS STAIRS
 - STRAIGHT STAIRS
- RECTANGULAR STAIR [SEE BACK PAGE]
- SPECIAL SHAPE STAIR
 - [INCLUDE DRAWING & DIMENSIONS]

Material [SEE BACK PAGE FOR AVAILABLE PATTERNS]

- 20 MIL.
- 28 MIL.

WALL MATERIAL _____

- HUNG (BEADED)
- OVERLAP OF _____ INCHES

BOTTOM MATERIAL _____

Type of Pool

- RESIDENTIAL
- PUBLIC

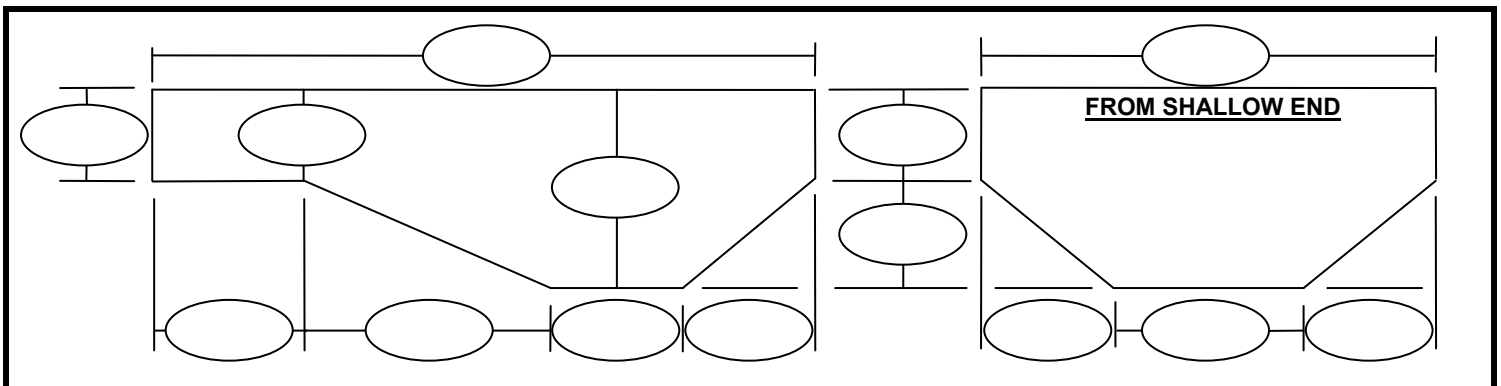

SPECIAL INSTRUCTIONS

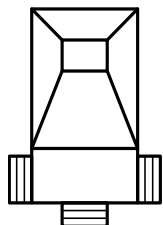

CIRCLE STAIR LOCATION

Location of Wall Seam

- NO PREFERENCE
- AT LOCATION SHOWN
 - [MUST INCLUDE DIMENSIONS]

GARRETT LINERS, INC. IS NOT RESPONSIBLE FOR PATTERN MISALIGNMENT.

POOL MANUFACTURER (IF KNOWN) _____

GRECIANS

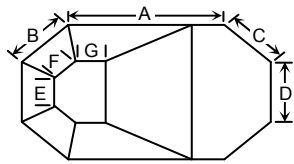

SIX SIDED HOPPER

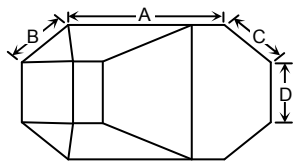

SQUARE HOPPER

DIMENSIONS	
A	
B	
C	
D	
E	
F	
G	

MATERIALS

WALL PATTERNS

20 OR 28 MIL

ALBION TILE BLUE LANCASHIRE TILE
 CAMBRIDGE TILE CARMEL TILE
 CRYSTAL TILE GREY LANCASHIRE TILE
 HAMILTON TILE PHOENIX TILE

TUDOR TILE

20 MIL

ATRIUM GOLD TILE CARRERA TILE
 CASCADE TILE CATALINA TILE
 CYPRUS TILE HAMPTON TILE
 MADISON TILE MAJESTIC TILE
 MOJAVE TILE NORTHERN LIGHTS TILE
 STARFISH TILE PRIMROSE TILE
 TROPICAL TILE

28 MIL

SEDONA TILE LAKESIDE TILE
 ROMA TILE SARATOGA TILE

BOTTOM PATTERNS

20 OR 28 MIL

ARCTIC ICE BLUE LAGUNA
 COBBLESTONE LAGUNA
 MOSAIC MYSTIC
 REFLECTIONS SANDSTONE

WHITE SPARKLE

20 MIL

BLUE SPARKLE FAIRFIELD
 FRESCO GLACIER
 MIRAGE OCEAN
 QUARTZ SHIMMER
 TUSCAN TYE DYE

OVALS

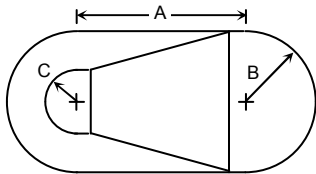

DIMENSIONS	
A	
B	
C	

[FOR SQUARE OR WEDGE TYPE BOTTOM, PLEASE INCLUDE A DRAWING]

IMPORTANT !

1. ALL MEASUREMENTS SHOULD BE ACCURATE HORIZONTAL AND VERTICAL DIMENSIONS WITH NO ALLOWANCE FOR STRETCH. MEASURE CAREFULLY, AND DON'T TAKE ANYTHING FOR GRANTED.
2. WALL HEIGHT DIMENSION IS THE FINISHED DIMENSION FROM BEAD HOLDER TO FLOOR, NOT THE PANEL HEIGHT. THIS CAN VARY AROUND THE POOL. SO MEASURE AT SHALLOW END WALL, AT BREAKOVER, AND AT DEEP END WALL AND NOTE ANY VARIATIONS.
3. PLEASE CHECK THAT ALL DIMENSIONS ADD UP TO ANY OVERALL DIMENSIONS.
4. PLEASE INDICATE IF BOTTOM AND/OR GUTTERS ARE ROUNDED.
5. ALL OVER BOTTOM PATTERN LINERS ARE AVAILABLE. PLEASE CONSULT THE PRICING SHEET FOR EXTRA CHARGES.

STAIRS

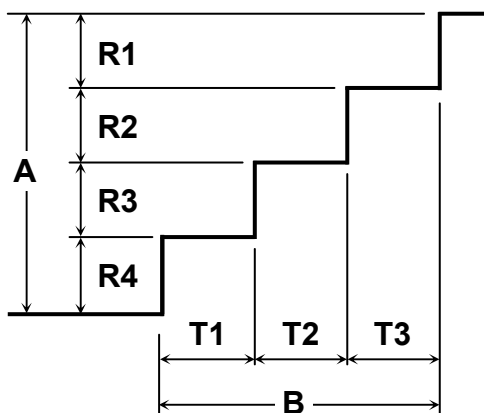

DIMENSIONS	
A	
B	
R1	
R2	
R3	
R4	
T1	
T2	
T3	

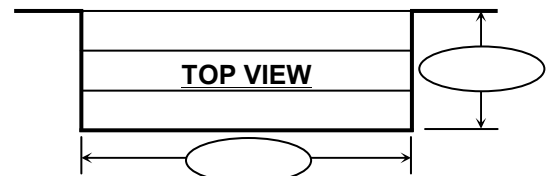

1. ARE STAIR CORNERS RADIUS, DIAGONAL, OR SQUARE?
 FRONT _____
 BACK _____
2. IS BOTTOM RISER FLUSH WITH WALL?
 YES
 NO, SET BACK _____ INCHES
3. DO YOU REQUIRE LOOPS OR TABS FOR RETAINING RODS ON STAIRS?
 LOOPS
 TABS
 NEITHER
4. BE SURE TO NOTE STAIR LOCATION ON FRONT.