

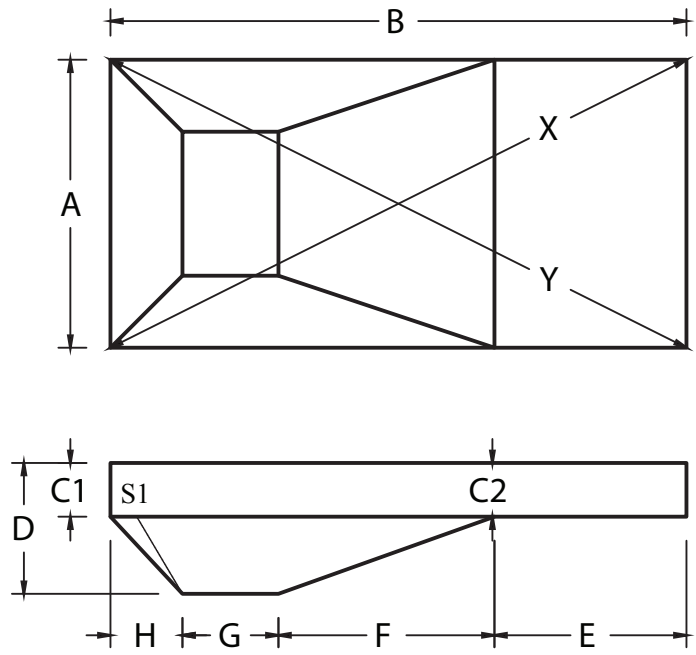

Customer:	Job Name:
Contact Person:	Fax:
www.garrettliners.com	Phone:

Wall: ga.	Bottom: ga.	Date:
-----------	-------------	-------

# Garrett Liners: Dimensions for Rectangle Hopper



## Dimensions

A	
B	
C1	
C2	
C3	
D	
E	
F	
G	
H	
K	
L	
M	
X	
Y	
Safety Ledge	
S1	
S2	
S3	

Diagonals are measured to: 90 Corner Center of Radius

Corners: Square  Radius  Diagonal  Size: \_\_\_\_\_

Safety Ledge: Y N Size: \_\_\_\_\_

Steps: Y N Fiberglass Stairs: Y N (note location)

Work space for any additional information or drawings

### Stairs

Stair Location

Center Shallow End

Right Shallow End

Left Shallow End

Other



Do the steps require:  
Pockets  Flaps  Bead

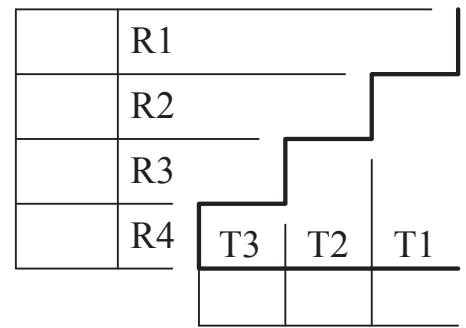

Please draw the step location. (draw for fiberglass steps as well)

### Flush Stairs

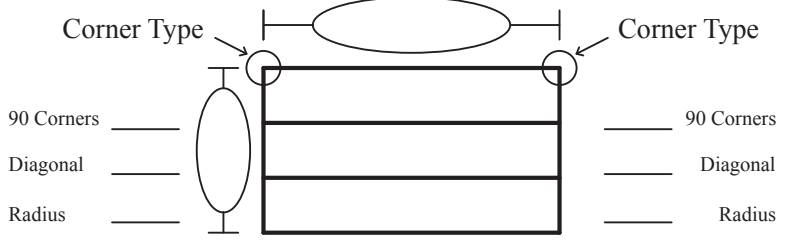

### Recessed Stairs

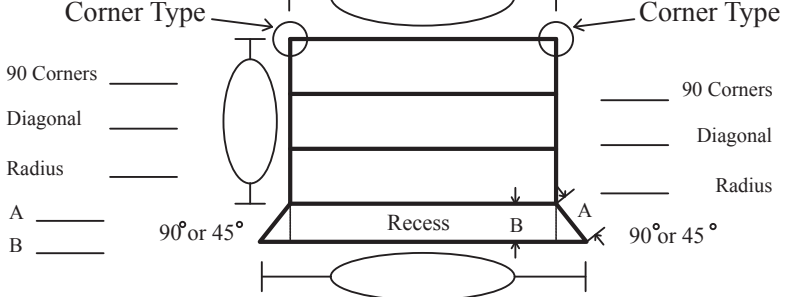

## Garrett Liners: Dimensions for True-L Right Hopper

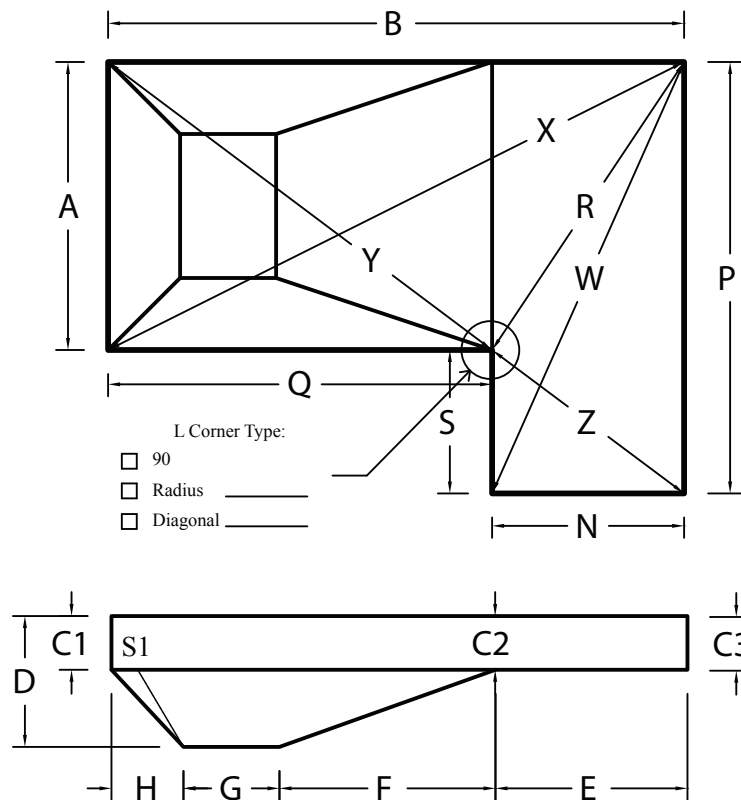

L Corner Type:

- 90  
 Radius \_\_\_\_\_  
 Diagonal \_\_\_\_\_

### Dimensions

A	
B	
C1	
C2	
C3	
D	
E	
F	
G	
H	
K	
L	
M	
N	
P	
Q	
R	
S	
W	
X	
Y	
Z	

### Safety Ledge

S1	
S2	
S3	

Diagonals are measured to: 90 Corner Center of Radius

 Corners: Square  Radius  Diagonal  Size:

Safety Ledge: Y N Size:

Steps: Y N Fiberglass Steps: Y N (note location)

Work space for any additional information or drawings

### Stairs

Do the steps require:

 Pockets  Flaps  Bead 

#### Stair Location

- Center Shallow End   
 Right Shallow End   
 Left Shallow End   
 Other

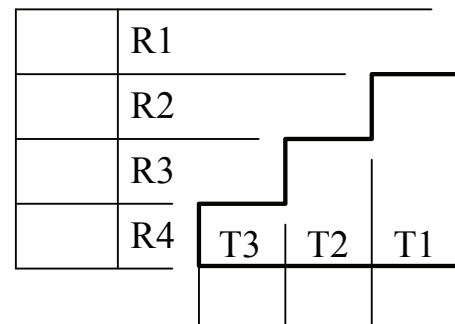

Please draw the step location. (draw for fiberglass steps as well)

### Flush Stairs

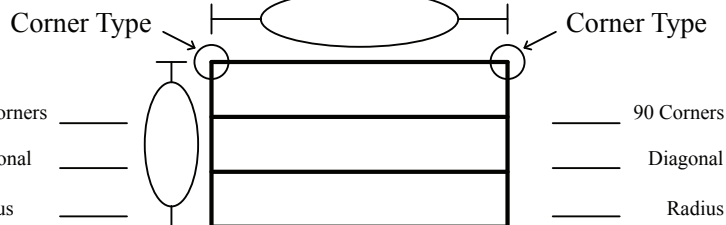

### Recessed Stairs

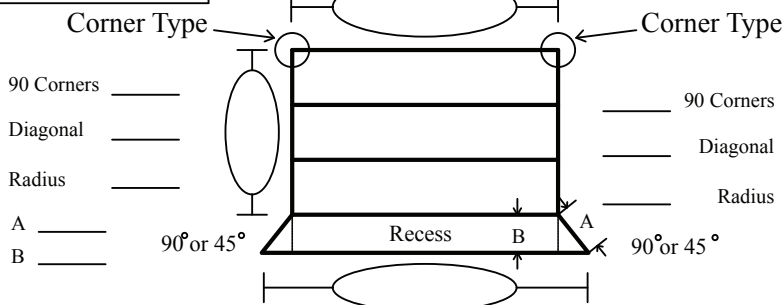

Customer: \_\_\_\_\_ Job Name: \_\_\_\_\_  
 Contact Person: \_\_\_\_\_ Fax: \_\_\_\_\_ Phone: \_\_\_\_\_  
 www.garrettliners.com

Wall: \_\_\_\_\_ ga. Bottom: \_\_\_\_\_ ga. Date: \_\_\_\_\_

## Garrett Liners: Dimensions for True-L Left Hopper

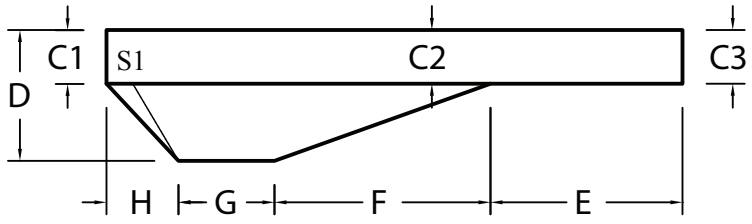
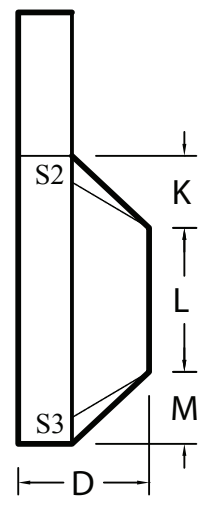
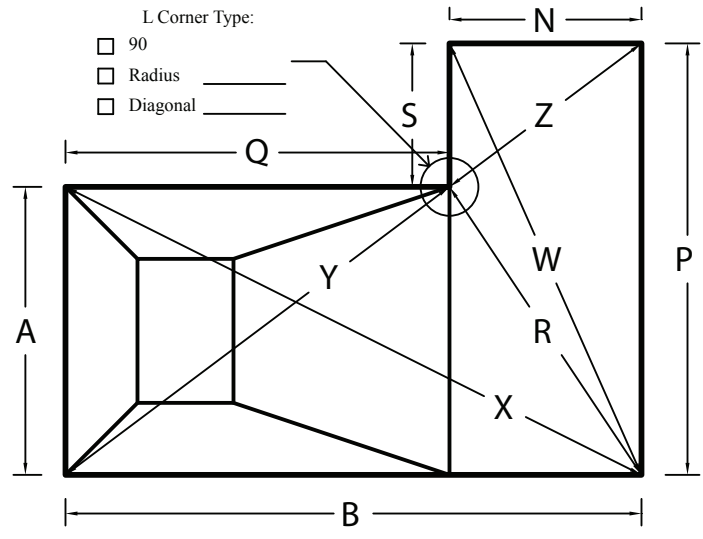

### Dimensions

A	
B	
C1	
C2	
C3	
D	
E	
F	
G	
H	
K	
L	
M	
N	
P	
Q	
R	
S	
W	
X	
Y	
Z	

### Safety Ledge

S1	
S2	
S3	

Diagonals are measured to: 90 Corner Center of Radius

Corners: Square  Radius  Diagonal  Size: \_\_\_\_\_

Safety Ledge: Y N Size: \_\_\_\_\_

Steps: Y N Fiberglass Steps: Y N (note location)

Work space for any additional information or drawings

### Stairs

Do the steps require:

Pockets  Flaps  Bead

#### Stair Location

- Center Shallow End
- Right Shallow End
- Left Shallow End
- Other

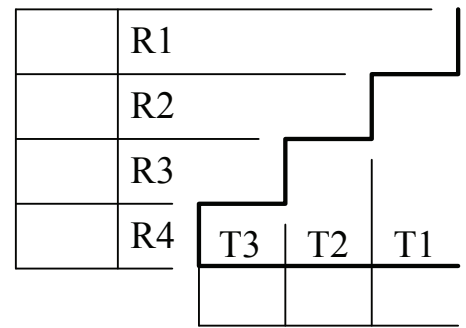
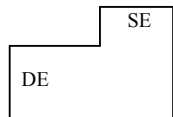

Please draw the step location. (draw for fiberglass steps as well)

### Flush Stairs

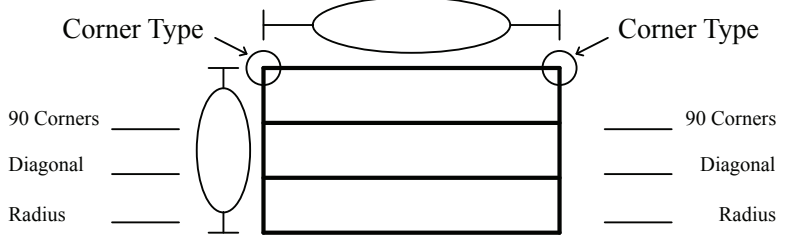

### Recessed Stairs

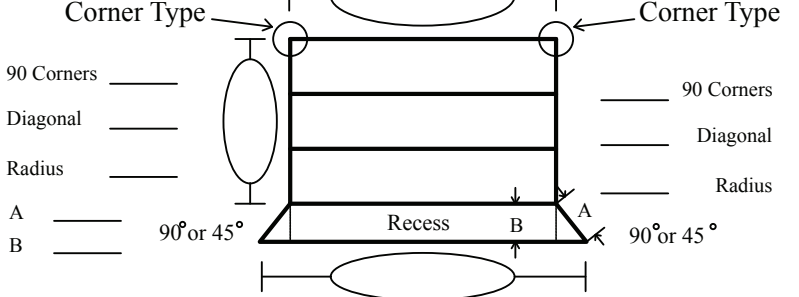

## Garrett Liners: Dimensions for Lazy-L Left Hopper

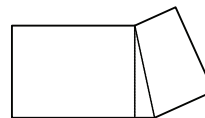
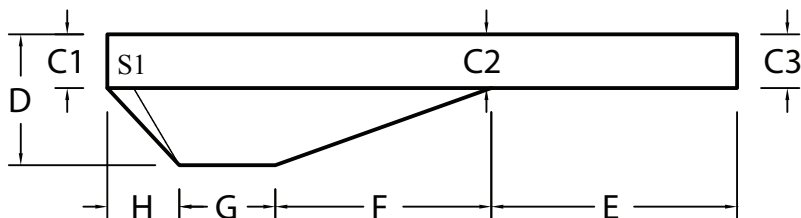
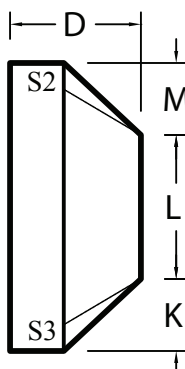
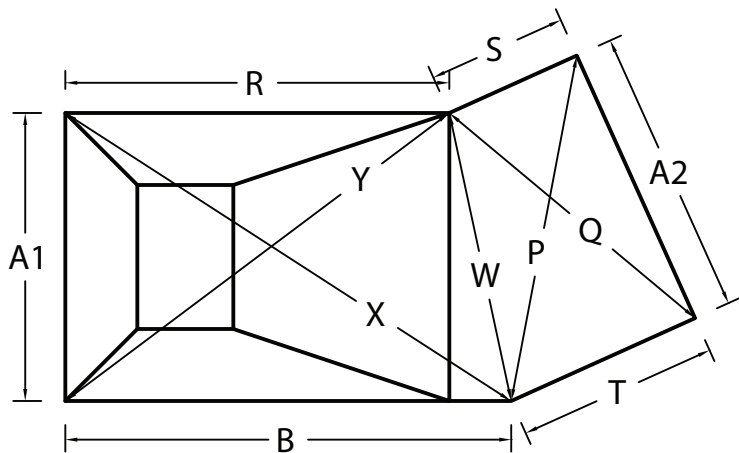

Break Line  
 Bend to Bend   
 Parallel

### Dimensions

A1	
A2	
B	
C1	
C2	
C3	
D	
E	
F	
G	
H	
K	
L	
M	
N	
P	
Q	
R	
S	
T	
W	
X	

Y	
Safety Ledge	
S1	
S2	
S3	

Diagonals are measured to: 90° Corner Center of Radius

Corners: Square  Radius  Diagonal  Size:

Safety Ledge: Y N Size:

Steps: Y N Fiberglass Stairs: Y N (note location)

Work space for any additional information or drawings

### Stairs

Do the steps require:

Pockets  Flaps  Bead

#### Stair Location

- Center Shallow End   
 Right Shallow End   
 Left Shallow End   
 Other

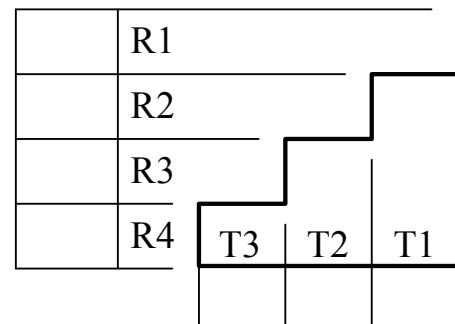

Please draw the step location. (draw for fiberglass steps as well)

### Flush Stairs

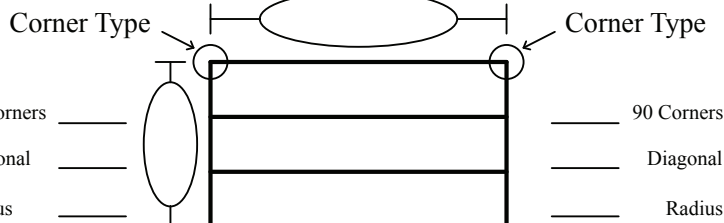

### Recessed Stairs

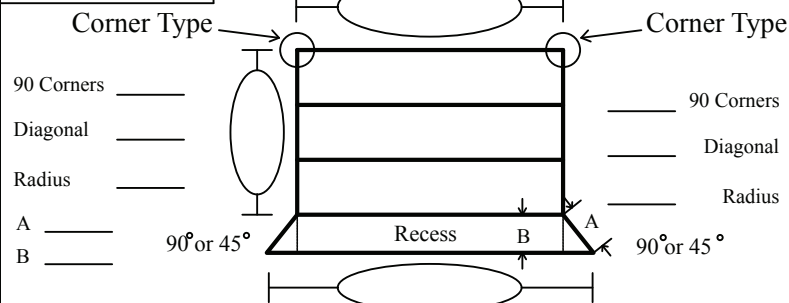

## Garrett Liners: Dimensions for Lazy-L Right Hopper

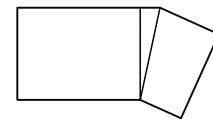
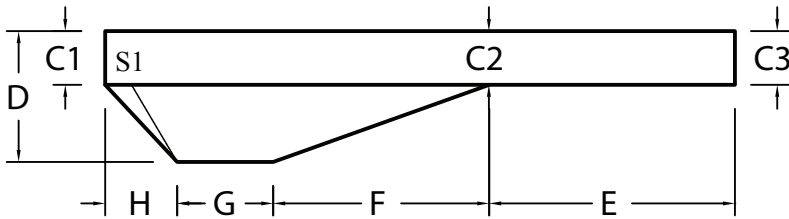
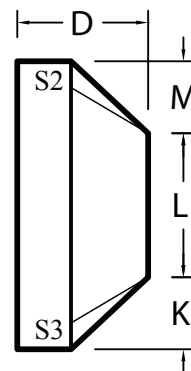
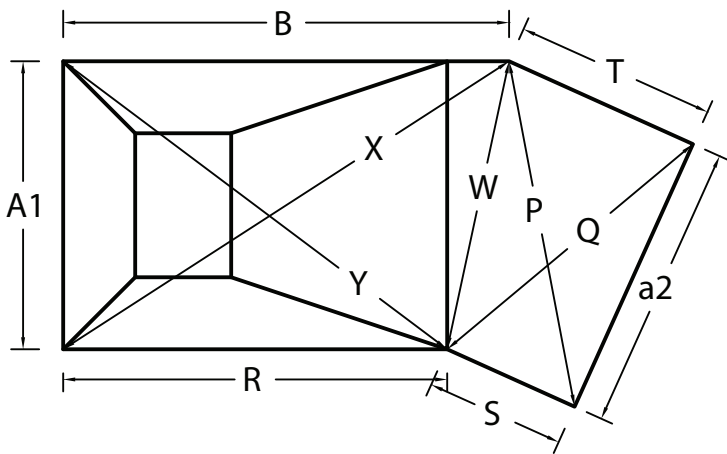

Break Line is:

- Bend to Bend   
 Parallel

### Dimensions

A1	
A2	
B	
C1	
C2	
C3	
D	
E	
F	
G	
H	
K	
L	
M	
N	
P	
Q	
R	
S	
T	
W	
X	

Y	
Safety Ledge	
S1	
S2	
S3	

Diagonals are measured to: 90 Corner Center of Radius

Corners: Square  Radius  Diagonal  Size:

Safety Ledge: Y N Size:

Steps: Y N Fiberglass Stairs: Y N (note location)

Work space for any additional information or drawings

### Stairs

Do the steps require:

Pockets  Flaps  Bead

#### Stair Location

- Center Shallow End   
 Right Shallow End   
 Left Shallow End   
 Other

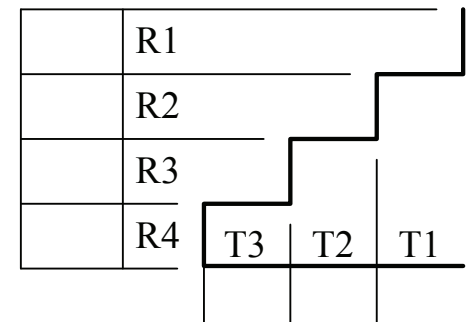
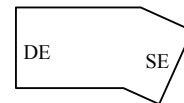

Please draw the step location. (draw for fiberglass steps as well)

### Flush Stairs

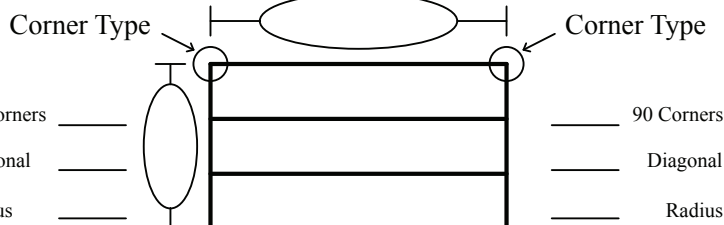

### Recessed Stairs

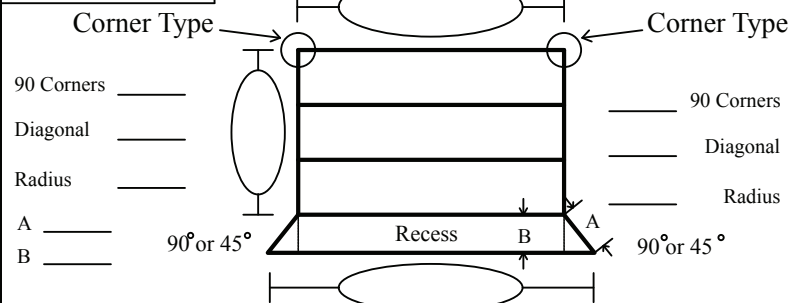

Customer:	Job Name:	
Contact Person:	Fax:	Phone:
Wall: ga.	Bottom: ga.	Date:

## Garrett Liners: Dimensions for Roman End Hopper

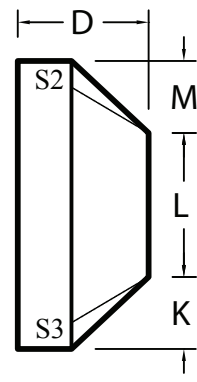
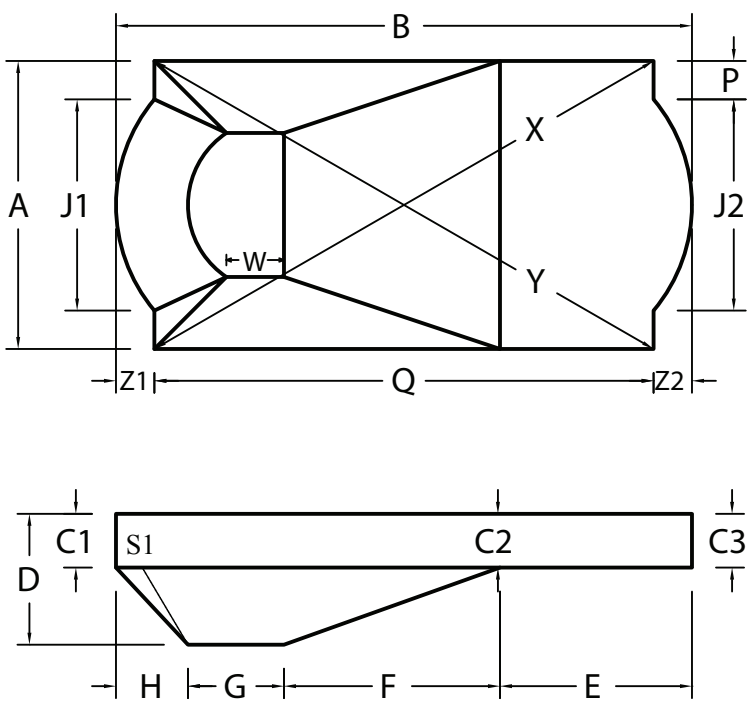

Dimensions	
A	
B	
C1	
C2	
C3	
D	
E	
F	
G	
H	
J1	
J2	
K	
L	
M	
Q	
P	
W	
X	
Y	
Z1	
Z2	

Safety Ledge	
S1	
S2	
S3	

Diagonals are measured to: 90 Corner Center of Radius

Corners: Square  Radius  Diagonal  Size:

Safety Ledge: Y N Size:

Steps: Y N Fiberglass Stairs: Y N (note location)

Work space for any additional information or drawings

**Stairs**

Do the steps require: Pockets  Flaps  Bead

Stair Location

Center Shallow End   
 Right Shallow End   
 Left Shallow End   
 Other

	R1		
	R2		
	R3		
R4	T3	T2	T1

Please draw the step location. (draw for fiberglass steps as well)

**Flush Stairs**

Corner Type

90 Corners \_\_\_\_\_  
 Diagonal \_\_\_\_\_  
 Radius \_\_\_\_\_

90 Corners \_\_\_\_\_  
 Diagonal \_\_\_\_\_  
 Radius \_\_\_\_\_

**Recessed Stairs**

Corner Type

90 Corners \_\_\_\_\_  
 Diagonal \_\_\_\_\_  
 Radius \_\_\_\_\_

A \_\_\_\_\_  
 B \_\_\_\_\_

90° or 45°

90° or 45°

## Garrett Liners: Dimensions for Grecian Hopper Square Pad

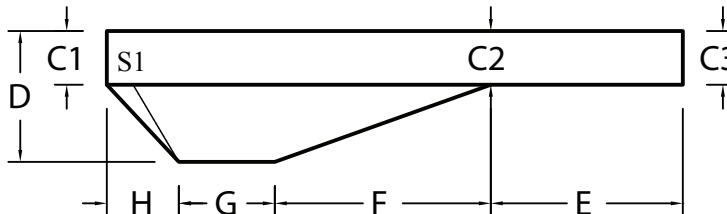
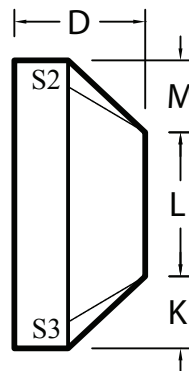
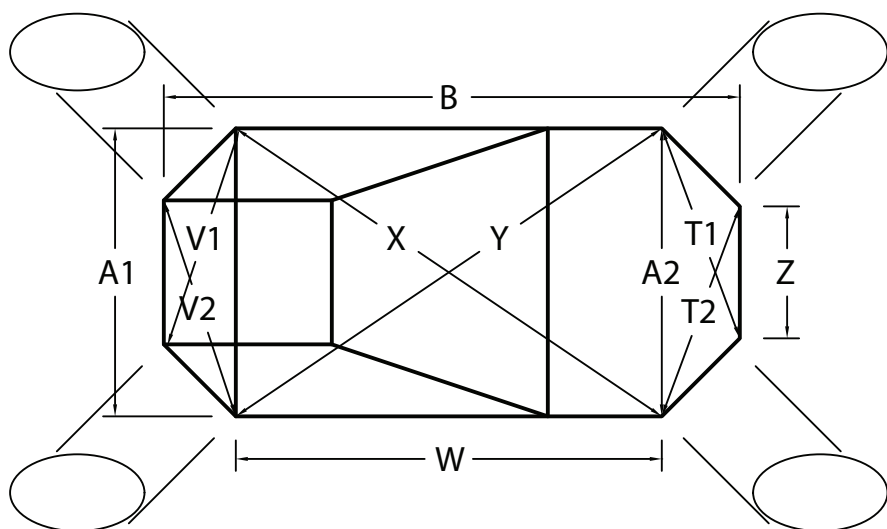

### Dimensions

A1	
A2	
B	
C1	
C2	
C3	
D	
E	
F	
G	
H	
K	
L	
M	
N	
T1	
T2	
Z	
V1	
V2	
W	
X	
Y	

S1	
S2	
S3	

### Safety Ledge

Corners: Square  Radius  Diagonal  Size:

Safety Ledge: Y N Size:

Steps: Y N Fiberglass Stairs: Y N (note location)

Work space for any additional information or drawings

### Stairs

Do the steps require:

Pockets  Flaps  Bead

#### Stair Location

- Center Shallow End   
 Right Shallow End   
 Left Shallow End   
 Other

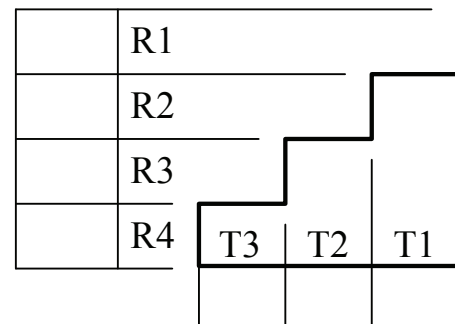

Please draw the step location. (draw for fiberglass steps as well)

### Flush Stairs

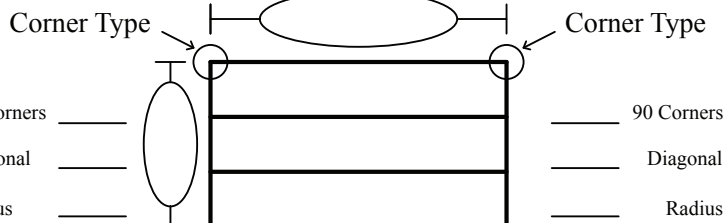

### Recessed Stairs

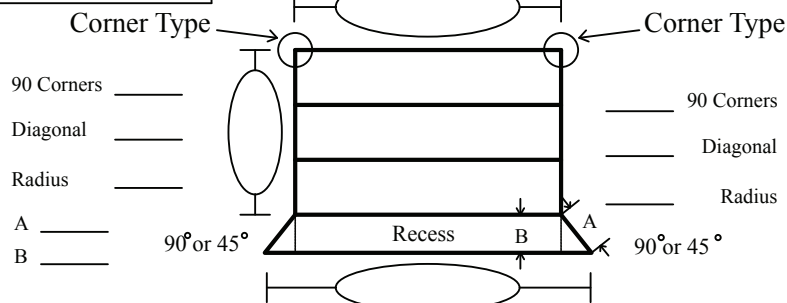

Customer:	Job Name:	
Contact Person:	Fax:	Phone:
www.garrettliners.com		

Wall: ga.	Bottom: ga.	Date:
-----------	-------------	-------

## Garrett Liners: Dimensions for Oval Hopper

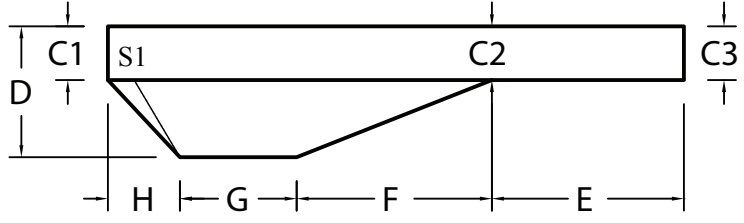
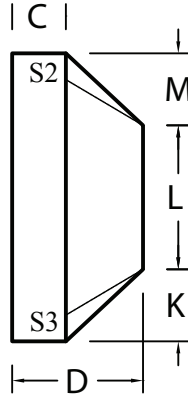
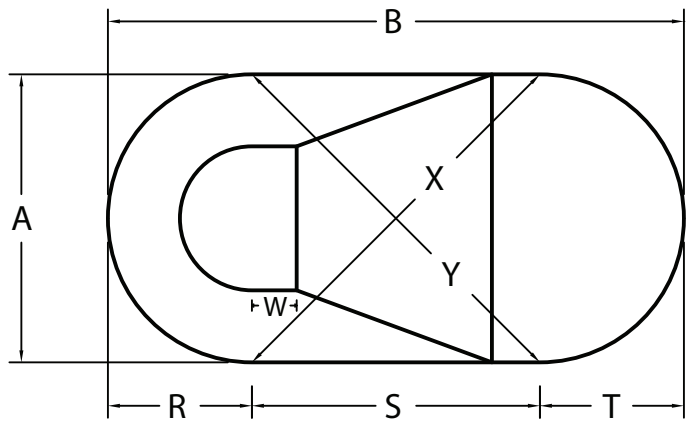

### Dimensions

A	
B	
C1	
C2	
C3	
D	
E	
F	
G	
H	
K	
L	
M	
R	
S	
T	
W	
X	
Y	

### Safety Ledge

S1	
S2	
S3	

Corners: Square  Radius  Diagonal  Size:

Safety Ledge: Y N Size:

Steps: Y N Fiberglass Stairs: Y N (note location)

Work space for any additional information or drawings

### Stairs

Do the steps require:

Pockets  Flaps  Bead

#### Stair Location

- Center Shallow End
- Right Shallow End
- Left Shallow End
- Other

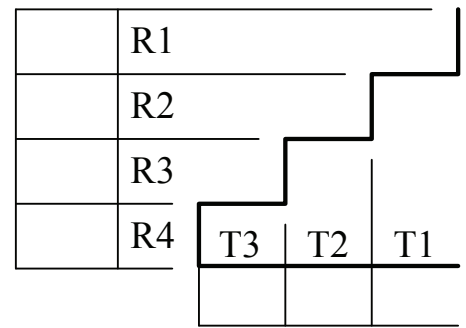

Please draw the step location. (draw for fiberglass steps as well)

### Flush Stairs

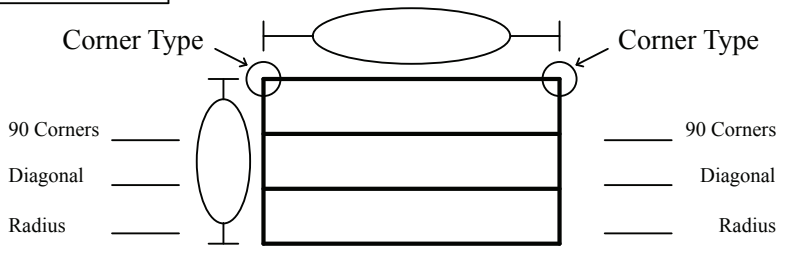

### Recessed Stairs

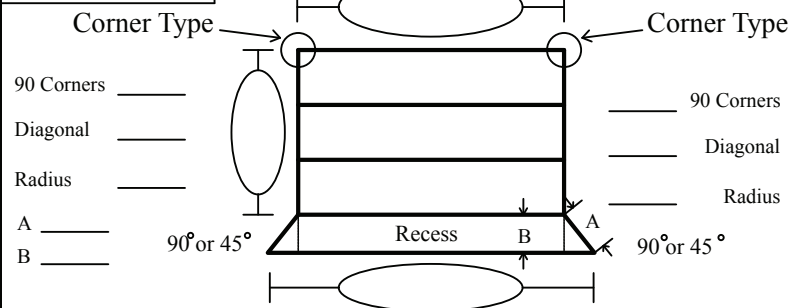



Customer:	Job Name:	
Contact Person:	Fax:	Phone:
Wall: ga.	Bottom: ga.	Date:

## Garrett Liners: Dimensions for Grecian Hopper

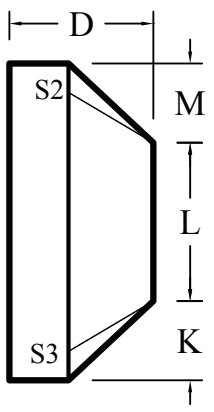
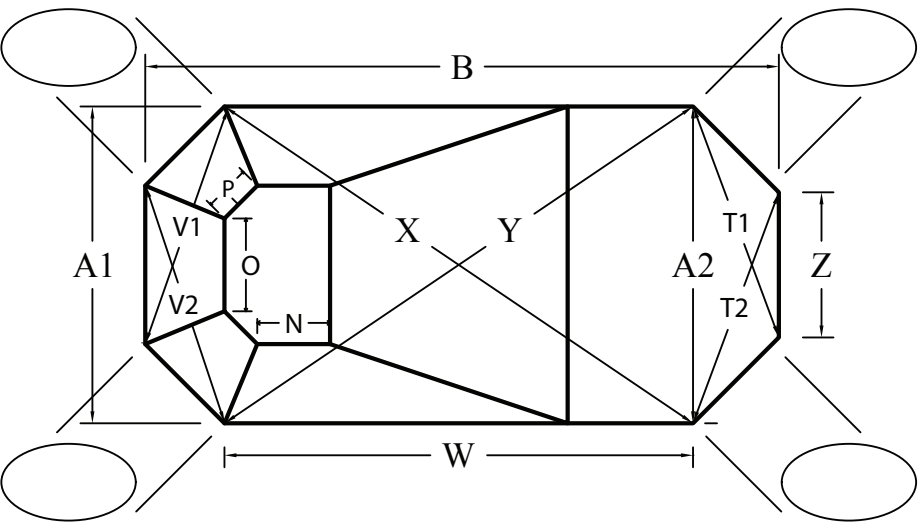

### Dimensions

A1	
A2	
B	
C1	
C2	
C3	
D	
E	
F	
G	
H	
K	
L	
M	
N	
O	
P	
T1	
T2	
V1	
V2	
W	

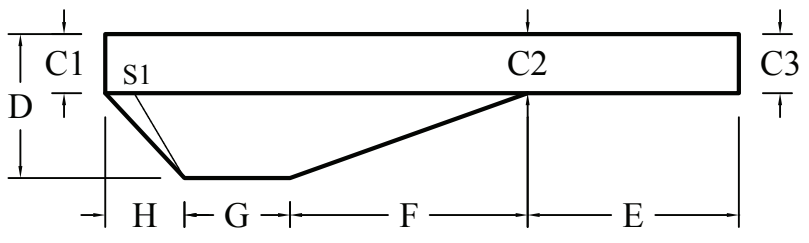

X	
Y	
Z	
<b>Safety Ledge</b>	
S1	
S2	
S3	

Corners: Square  Radius  Diagonal  Size: \_\_\_\_\_

Safety Ledge: Y N Size: \_\_\_\_\_

Steps: Y N Fiberglass Stairs: Y N (note location)

Work space for any additional information or drawings

### Stairs

- Stair Location
- Center Shallow End
  - Right Shallow End
  - Left Shallow End
  - Other



Do the steps require:  
Pockets  Flaps  Bead

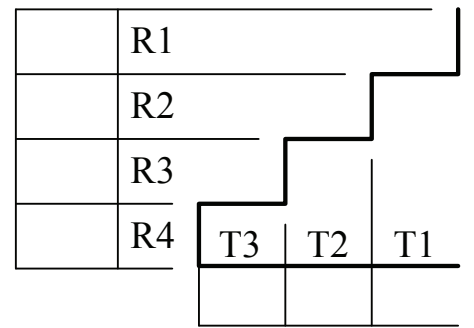

Please draw the step location. (draw for fiberglass steps as well)

### Flush Stairs

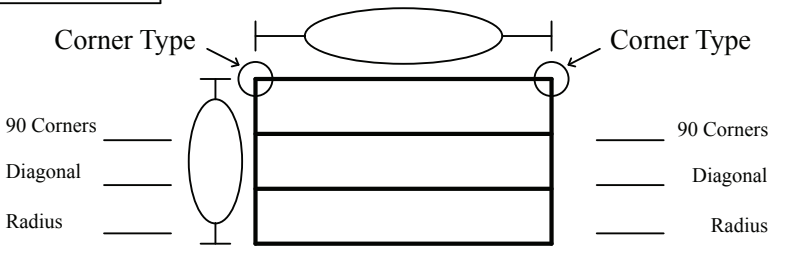

### Recessed Stairs

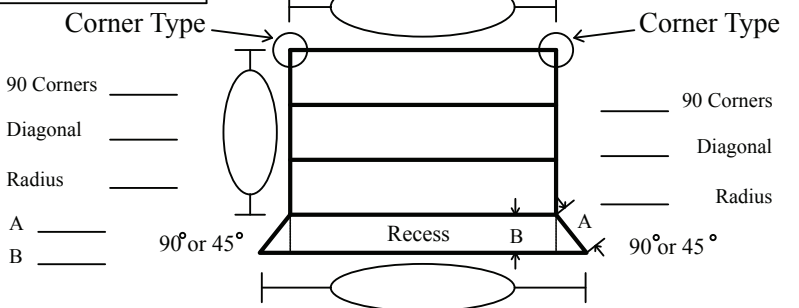

Customer: _____	Job Name: _____	Phone: _____
Contact Person: _____	Fax: _____	_____

Wall: _____ ga.	Bottom: _____ ga.	Date: _____
-----------------	-------------------	-------------

## Garrett Liners: Dimensions for Grecian True-L Left Hopper

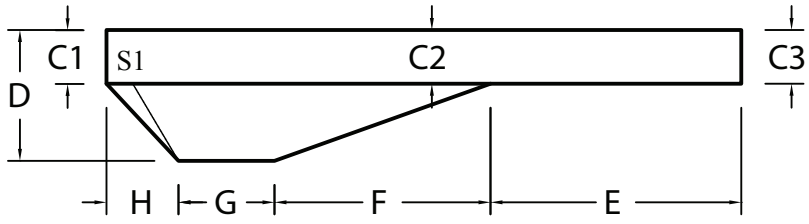
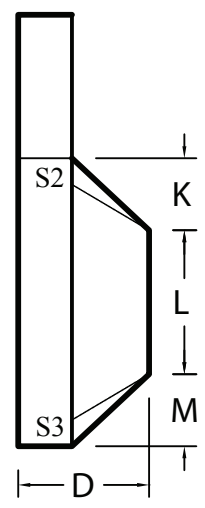
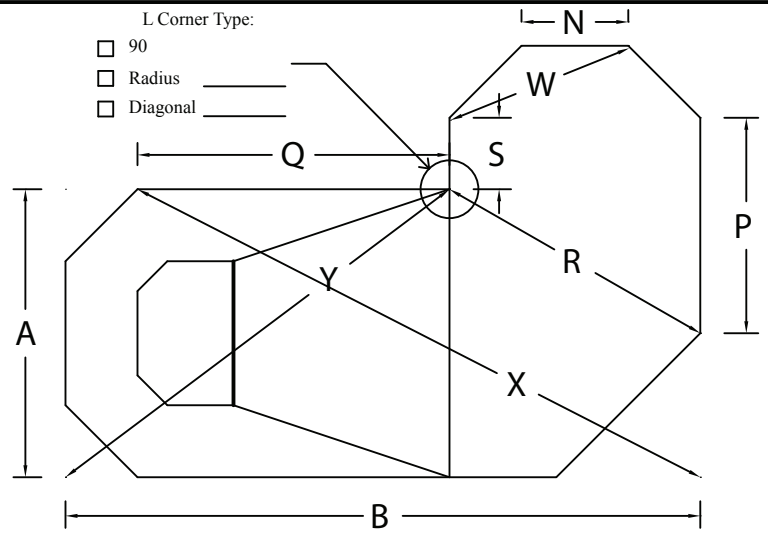

Dimensions	
A	_____
B	_____
C1	_____
C2	_____
C3	_____
D	_____
E	_____
F	_____
G	_____
H	_____
K	_____
L	_____
M	_____
N	_____
P	_____
Q	_____
R	_____
S	_____
W	_____
X	_____
Y	_____
Z	_____

Safety Ledge	
S1	_____
S2	_____
S3	_____

Diagonals are measured to: 90 Corner Center of Radius

Corners: Square  Radius  Diagonal  Size: \_\_\_\_\_

Safety Ledge: Y N Size: \_\_\_\_\_

Steps: Y N Fiberglass Steps: Y N (note location)

Work space for any additional information or drawings

### Stairs

Stair Location

Center Shallow End

Right Shallow End

Left Shallow End

Other

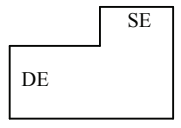

Do the steps require:  
 Pockets  Flaps  Bead

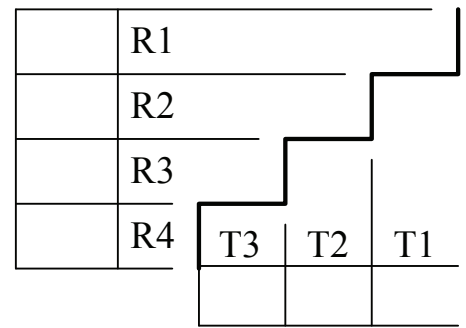

Please draw the step location. (draw for fiberglass steps as well)

### Flush Stairs

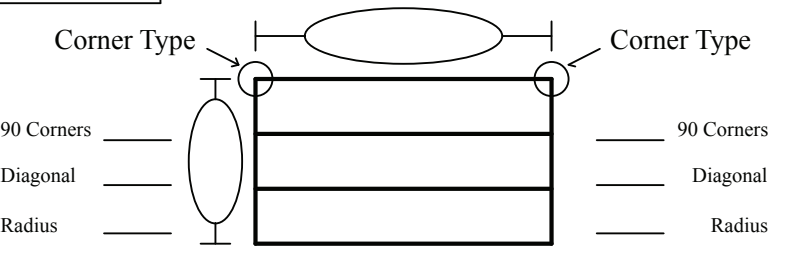

### Recessed Stairs

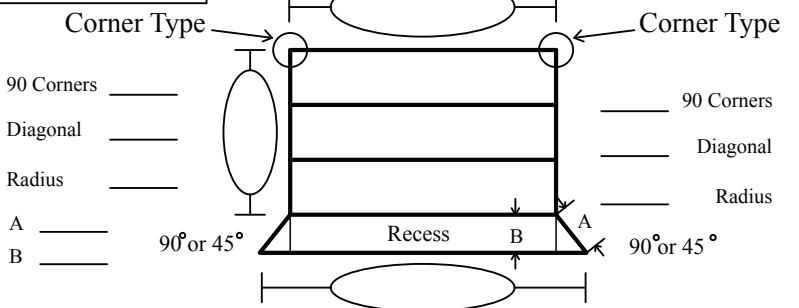

Customer:	Job Name:
Contact Person:	Fax:
www.garrettliners.com	Phone:

Wall: ga.	Bottom: ga.	Date:
-----------	-------------	-------

## Garrett Liners: Dimensions for Grecian Lazy-L

### Dimensions

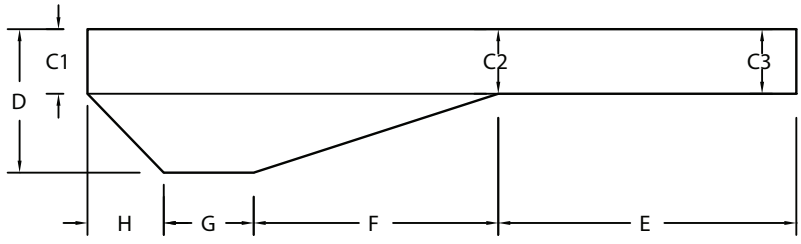
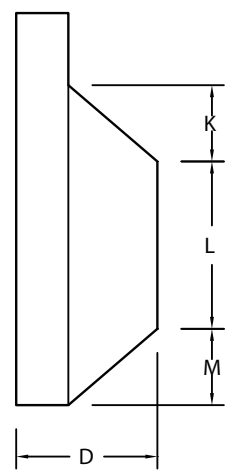
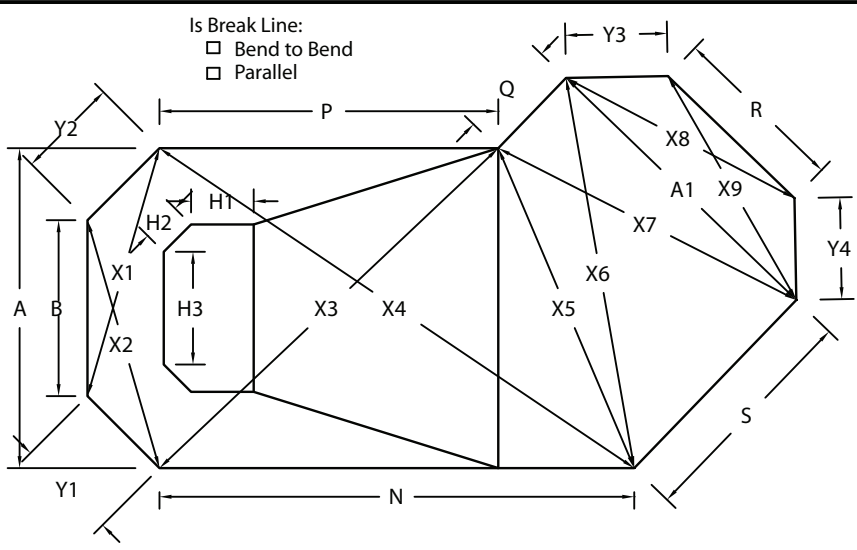

A	
A1	
B	
C1	
C2	
C3	
D	
E	
F	
G	
H	
K	
L	
M	
N	
P	
Q	
R	
S	
Y1	
Y2	
Y3	
Y4	
X1	
X2	
X3	
X4	
X5	
X6	
X7	
X8	
X9	

Safety Ledge: Y N Size:

Steps: Y N Fiberglass Stairs: Y N (note location)

Work space for any additional information or drawings

### Stairs

Do the steps require:  
 Pockets  Flaps  Bead

#### Stair Location

- Center Shallow End
- Right Shallow End
- Left Shallow End
- Other

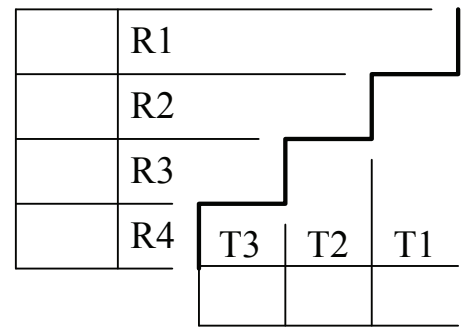
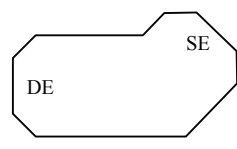

Please draw the step location. (draw for fiberglass steps as well)

### Flush Stairs

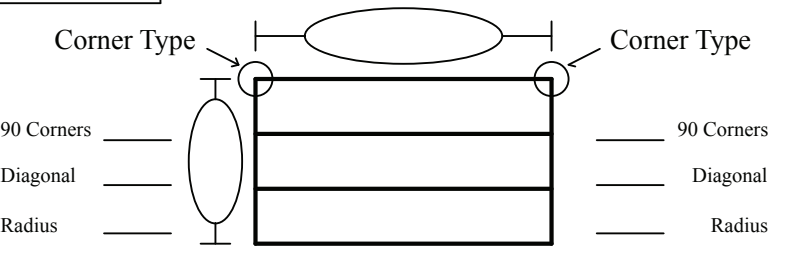

### Recessed Stairs

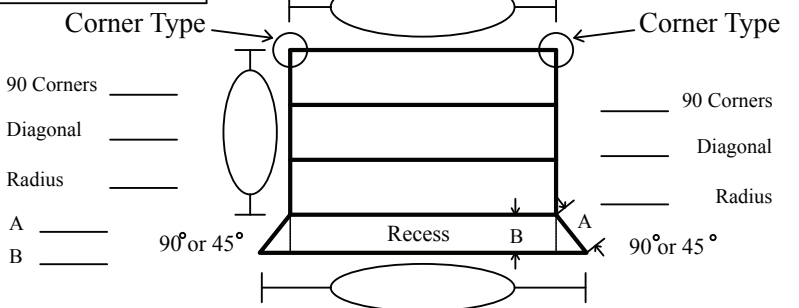



Customer:

Job Name:

Contact Person:

Fax:

Phone:

www.garrettliners.com

Wall:

Bottom:

Date:

Garrett Liners: AB's for Free-Form Pools - Liners

#	A	B	#	A	B	#	A	B	#	A	B
1			21			41			61		
2			22			42			62		
3			23			43			63		
4			24			44			64		
5			25			45			65		
6			26			46			66		
7			27			47			67		
8			28			48			68		
9			29			49			69		
10			30			50			70		
11			31			51			71		
12			32			52			72		
13			33			53			73		
14			34			54			74		
15			35			55			75		
16			36			56			76		
17			37			57			77		
18			38			58			78		
19			39			59			79		
20			40			60			80		

Steps: Y N Fiberglass Stairs: Y N Safety Ledge: Y N Size:

Hopper Points

Work space for pool representation and additional information or drawings

#	A	B
Y1		
Y2		
Y3		
Y4		
Y5		
Y6		
X1		
X2		
X3		
X4		



Customer:

Job Name:

Contact Person:

Fax:

Phone:

www.garrettliners.com

Wall:

Bottom:

Date:

Garrett Liners: AB's for Free-Form Pools - Liners

#	A	B	#	A	B	#	A	B	#	A	B
1			21			41			61		
2			22			42			62		
3			23			43			63		
4			24			44			64		
5			25			45			65		
6			26			46			66		
7			27			47			67		
8			28			48			68		
9			29			49			69		
10			30			50			70		
11			31			51			71		
12			32			52			72		
13			33			53			73		
14			34			54			74		
15			35			55			75		
16			36			56			76		
17			37			57			77		
18			38			58			78		
19			39			59			79		
20			40			60			80		

Steps: Y N Fiberglass Stairs: Y N Safety Ledge: Y N Size:

Hopper Points

Work space for pool representaion and additional information or drawings

#	A	B
Y1		
Y2		
Y3		
Y4		
X1		
X2		
X3		

Stairs

- Stair Location
- Center Shallow End
  - Right Shallow End
  - Left Shallow End
  - Other

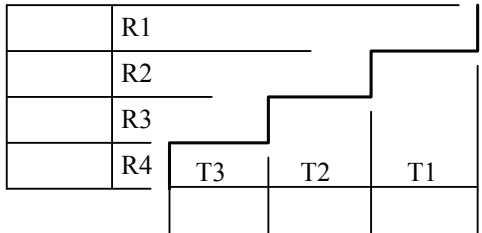

Stairs

- Corners
- 90 Corners
  - Diagonal Corners
  - Diagonal \_\_\_\_\_
  - Radiused Corners
  - Radius \_\_\_\_\_
  - Recessed

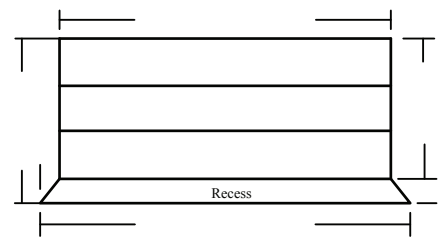



Customer: \_\_\_\_\_  
 Contact Person: \_\_\_\_\_

Job Name: \_\_\_\_\_  
 Phone: \_\_\_\_\_ Date: \_\_\_\_\_

www.garrettliners.com

Material: \_\_\_\_\_ Color: \_\_\_\_\_ Strap Spacing: \_\_\_\_\_ Pump:  Drain Strip:

**Garrett Liners: AB's for Free-Form Pools - Covers**

#	A	B	#	A	B	#	A	B	#	A	B
1			21			41			61		
2			22			42			62		
3			23			43			63		
4			24			44			64		
5			25			45			65		
6			26			46			66		
7			27			47			67		
8			28			48			68		
9			29			49			69		
10			30			50			70		
11			31			51			71		
12			32			52			72		
13			33			53			73		
14			34			54			74		
15			35			55			75		
16			36			56			76		
17			37			57			77		
18			38			58			78		
19			39			59			79		
20			40			60			80		

Steps: Y N Step Size: \_\_\_\_\_ Diving Board: Y N Raised Wall: Y N

Up and Over: Y N At Least 3 Feet of Deck: Y N Obstructions: Y N

**Special Hardware:**

Work space for pool representaion and additional information or drawings

- Lawn Tubes:
- Flanges:
- Wood Deck Anchors:
- Heavy Duty Springs:
- Duel Coil Springs:
- Short Springs:
- D-Rings:
- Snap Hooks:
- Cable:
- Wall Anchors:
- U-Clamps:
- Turn Buckles: